

FCC Test Report

Report No.: FD200213D06

Test Model: RES-3000-8665U

Series Model: RES-3XXXXXXXXXXXXXXXXXXXXX
(“X” can be 0-9, A-Z or blank for marketing purpose)

Received Date: Feb. 12, 2020

Test Date: Feb. 12 to 15, 2020

Issued Date: Feb. 20, 2020

Applicant: Vecow Co., Ltd.

Address: 3F., No.10, Jiankang Rd., Zhonghe Dist., New Taipei City 23586, Taiwan

Issued By: Bureau Veritas Consumer Products Services (H.K.) Ltd., Taoyuan Branch
Lin Kou Laboratories

Lab Address: No. 47-2, 14th Ling, Chia Pau Vil., Lin Kou Dist., New Taipei City, Taiwan

**FCC Registration/
Designation Number:** 418586 / TW1078



This report is for your exclusive use. Any copying or replication of this report to or for any other person or entity, or use of our name or trademark, is permitted only with our prior written permission. This report sets forth our findings solely with respect to the test samples identified herein. The results set forth in this report are not indicative or representative of the quality or characteristics of the lot from which a test sample was taken or any similar or identical product unless specifically and expressly noted. Our report includes all of the tests requested by you and the results thereof based upon the information that you provided to us. You have 60 days from date of issuance of this report to notify us of any material error or omission caused by our negligence, provided, however, that such notice shall be in writing and shall specifically address the issue you wish to raise. A failure to raise such issue within the prescribed time shall constitute your unqualified acceptance of the completeness of this report, the tests conducted and the correctness of the report contents. Unless specific mention, the uncertainty of measurement has been explicitly taken into account to declare the compliance or non-compliance to the specification. The report must not be used by the client to claim product certification, approval, or endorsement by A2LA or any agency of the U.S. government. The report must not be used by the client to claim product certification, approval, or endorsement by TAF or any government agencies.

Table of Contents

Release Control Record	3
1 Certificate of Conformity	4
2 Summary of Test Results	5
2.1 Measurement Uncertainty	5
2.2 Modification Record	5
3 General Information	6
3.1 Description of EUT	6
3.2 Features of EUT	6
3.3 Operating Modes of EUT and Determination of Worst Case Operating Mode	7
3.4 Test Program Used and Operation Descriptions.....	7
3.5 Primary Clock Frequencies of Internal Source	7
4 Configuration and Connections with EUT	8
4.1 Connection Diagram of EUT and Peripheral Devices	8
4.2 Configuration of Peripheral Devices and Cable Connections	9
5 Conducted Emissions at Mains Ports	10
5.1 Limits	10
5.2 Test Instruments	10
5.3 Test Arrangement	11
5.4 Test Results	12
6 Radiated Emissions up to 1 GHz	14
6.1 Limits	14
6.2 Test Instruments	14
6.3 Test Arrangement	15
6.4 Test Results	16
7 Radiated Emissions above 1 GHz	18
7.1 Limits	18
7.2 Test Instruments	19
7.3 Test Arrangement	20
7.4 Test Results	21
8 Pictures of Test Arrangements	23
8.1 Conducted Emissions at Mains Ports	23
8.2 Radiated Emissions up to 1 GHz	24
8.3 Radiated Emissions above 1 GHz	25
Appendix – Information of the Testing Laboratories	26



Release Control Record

Issue No.	Description	Date Issued
FD200213D06	Original release.	Feb. 20, 2020

1 Certificate of Conformity

Product: RES-3000 Series

Brand: Vecow

Test Model: RES-3000-8665U

Series Model: RES-3XXXXXXXXXXXXXXXXXXXXX ("X" can be 0-9, A-Z or blank for marketing purpose)

Sample Status: Engineering sample

Applicant: Vecow Co., Ltd.

Test Date: Feb. 12 to 15, 2020

Standards: 47 CFR FCC Part 15, Subpart B, Class A
ICES-003: 2016 Issue 6, updated Apr. 2019 Class A
ANSI C63.4:2014

The above equipment has been tested by **Bureau Veritas Consumer Products Services (H.K.) Ltd., Taoyuan Branch**, and found compliance with the requirement of the above standards. The test record, data evaluation & Equipment Under Test (EUT) configurations represented herein are true and accurate accounts of the measurements of the sample's EMC characteristics under the conditions specified in this report.

Prepared by : Sandra Lin , **Date:** Feb. 20, 2020
Sandra Lin / Specialist

Approved by : Jim Hsiang , **Date:** Feb. 20, 2020
Jim Hsiang / Associate Technical Manager

2 Summary of Test Results

47 CFR FCC Part 15, Subpart B / ICES-003: 2016 Issue 6, updated Apr. 2019 Class A

ANSI C63.4:2014

FCC Clause	ICES-003 Clause	Test Item	Result/Remarks	Verdict
15.107	6.1	AC Power Line Conducted Emissions	Minimum passing Class A margin is -20.11 dB at 0.23075 MHz	Pass
15.109	6.2.1	Radiated Emissions up to 1 GHz	Minimum passing Class A margin is -0.70 dB at 742.50 MHz	Pass
	6.2.2	Radiated Emissions above 1 GHz	Minimum passing Class A margin is -6.33 dB at 3712.48 MHz	Pass

Note:

1. There is no deviation to the applied test methods and requirements covered by the scope of this report.
2. Determining compliance based on the results of the compliance measurement, not taking into account measurement instrumentation uncertainty.

2.1 Measurement Uncertainty

Where relevant, the following measurement uncertainty levels have been estimated for tests performed on the EUT:

Measurement	Frequency	Expanded Uncertainty (k=2) (±)
Conducted Emissions at mains ports	150kHz ~ 30MHz	3.00 dB
Radiated Emissions up to 1 GHz	30MHz ~ 1GHz	4.25 dB
Radiated Emissions above 1 GHz	Above 1GHz	4.96 dB

2.2 Modification Record

There were no modifications required for compliance.

3 General Information

3.1 Description of EUT

Product	RES-3000 Series
Brand	Vecow
Test Model	RES-3000-8665U
Series Model	RES-3XXXXXXXXXXXXXXXXXXXXX (“X” can be 0-9, A-Z or blank for marketing purpose)
Model Difference	Marketing Differentiation
Sample Status	Engineering sample
Operating Software	WIN10
Power Supply Rating	24Vdc from adapter
Accessory Device	Adapter
Data Cable Supplied	N/A

Note:

1. The EUT is a RES-3000 Series with following interfaces:

- ✧ USB 2.0
- ✧ DVI (resolution up to 1920 x 1200 @ 60Hz)
- ✧ COM 2 (RS-232)
- ✧ COM 3 (RS-232)
- ✧ LAN*2 (10/100/1000Mbps)
- ✧ DC input

2. The EUT uses following adapter.

Brand	MEAN WELL
Model	GST160A24
Input Power	100-240V, 50/60Hz, 2.0A
Output Power	24V, 6.67A, 160W
Power Line	AC 3-Pin, Non-shielded DC (1.2m) with one ferrite core

3.2 Features of EUT

1. The tests reported herein were performed according to the method specified by Vecow Co., Ltd., for detailed feature description, please refer to the manufacturer's specifications or user's manual.

2. The EUT was configured with the following key components:

Component	Brand/Model/Specification
CPU	Intel® Core™ i7-8665UE Processor 1.70GHz
SSD	Innodisk 64GB 2.5" SATA SSD 3ME4, Industrial, W/T Grade
RAM	DDR4 2133 ECC SODIMM / innodisk / M4D0-AGS1QCGR / 16GB

3.3 Operating Modes of EUT and Determination of Worst Case Operating Mode

Test modes are presented in the report as below.

Mode	Test Condition	Input Power
1	Full system, DVI (resolution up to 1920 x 1200 @ 60Hz)	120Vac/ 60Hz

3.4 Test Program Used and Operation Descriptions

- a. Turned on the power of all equipment.
- b. EUT ran a test program to enable all functions.
- c. EUT read and wrote messages from/to HDD.
- d. EUT sent and received messages to/ from Notebook PCs (kept in a remote area) via two UTP LAN cables (each 10m).
- e. EUT sent messages to ext. LCD Monitor. Then it displayed messages on their screen.
- f. Steps c-e were repeated.

3.5 Primary Clock Frequencies of Internal Source

The highest frequency generated or used within the EUT or on which the EUT operates or tunes is 4.4GHz, provided by Vecow Co., Ltd., for detailed internal source, please refer to the manufacturer's specifications.

4 Configuration and Connections with EUT

4.1 Connection Diagram of EUT and Peripheral Devices

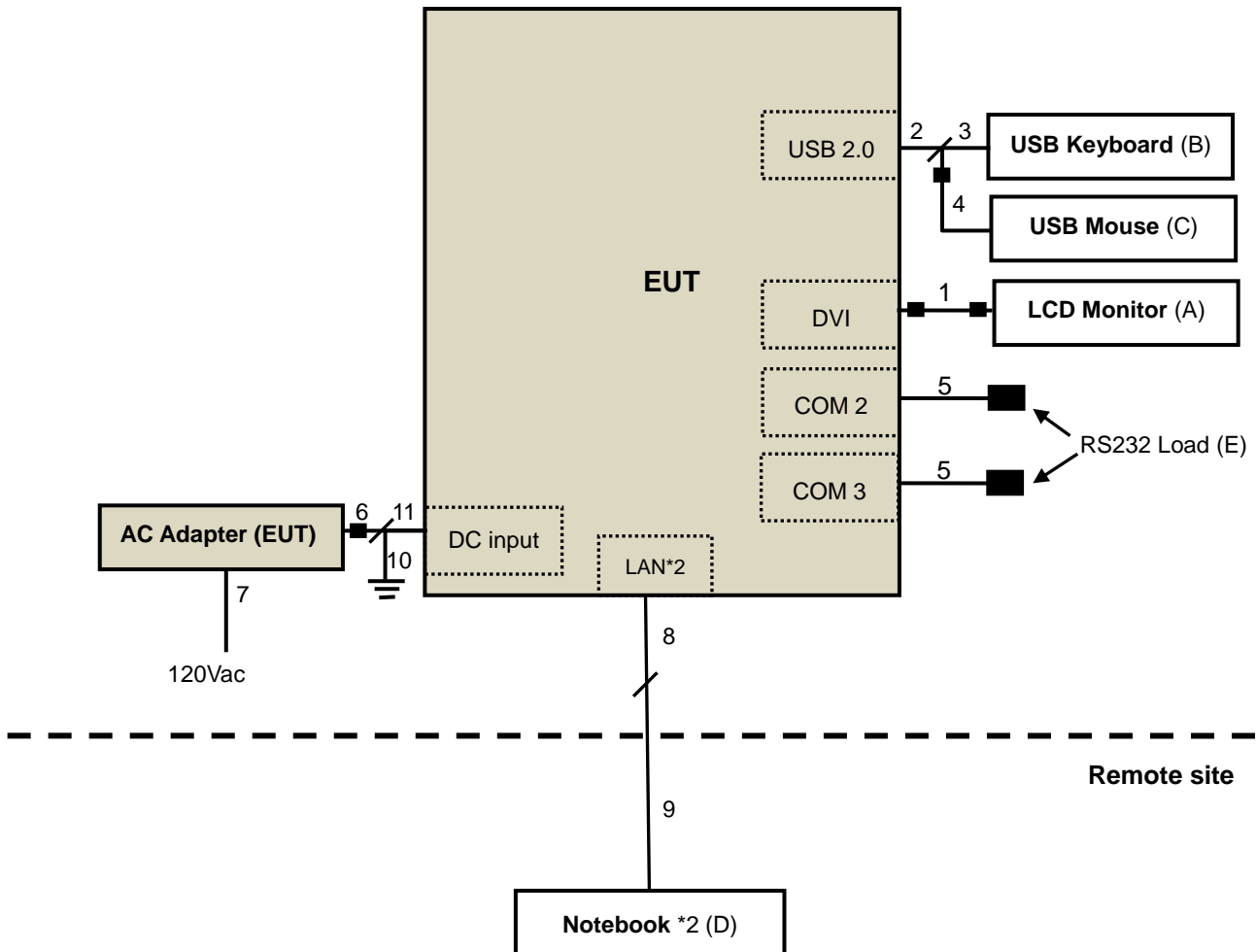

4.2 Configuration of Peripheral Devices and Cable Connections

ID	Product	Brand	Model No.	Serial No.	FCC ID	Remarks
A.	LCD Monitor	HP	HSTND-3781-Q	CNK5340QBP T	FCC DoC Approved	Provided by Lab
B.	USB Keyboard	Dell	KB216t	CN-0W33XP-LO300-7CL-1909	N/A	Provided by Lab
C.	USB Mouse	Microsoft	1113	9170528318308	FCC DoC Approved	Provided by Lab
D.	Notebook PC	LENOVO	T480	PF1EK03U	FCC DoC Approved	Provided by Lab
	Notebook PC	LENOVO	T480	PF1EZSAW	FCC DoC Approved	Provided by Lab
E.	RS232 LOAD *2	N/A	N/A	N/A	N/A	Supplied by client

Note:

1. All power cords of the above support units are non-shielded (1.8m).
2. Items E acted as communication partners to transfer data.

ID	Cable Descriptions	Qty.	Length (m)	Shielding (Yes/No)	Cores (Qty.)	Remarks
1.	DVI cable	1	1.8	Y	2	Provided by Lab
2.	USB cable	1	2.0	Y	0	Provided by Lab
3.	USB cable	1	1.8	Y	0	Provided by Lab
4.	USB cable	1	1.8	Y	1	Provided by Lab
5.	RS232 cable	2	2.0	Y	0	Provided by Lab
6.	DC power cable	1	1.2	N	1	Supplied by client
7.	AC power cable	1	1.8	N	0	Supplied by client
8.	LAN cable	2	1.0	N	0	Provided by Lab (RJ45, Cat.5e)
9.	LAN cable	2	10.0	N	0	Provided by Lab (RJ45, Cat.5e)
10.	GND cable	1	2.0	N	0	Provided by Lab
11.	DC power cable	1	1.8	N	0	Provided by Lab

Note: The core(s) is(are) originally attached to the cable(s).

5 Conducted Emissions at Mains Ports

5.1 Limits

Frequency (MHz)	Class A (dBuV)		Class B (dBuV)	
	Quasi-peak	Average	Quasi-peak	Average
0.15 - 0.5	79	66	66 - 56	56 - 46
0.50 - 5.0	73	60	56	46
5.0 - 30.0	73	60	60	50

Notes: 1. The lower limit shall apply at the transition frequencies.
2. The limit decreases linearly with the logarithm of the frequency in the range of 0.15 to 0.50 MHz.

5.2 Test Instruments

Description & Manufacturer	Model No.	Serial No.	Cal. Date	Cal. Due
ROHDE & SCHWARZ TEST RECEIVER	ESCS 30	838251/021	Oct. 30, 2019	Oct. 29, 2020
ROHDE & SCHWARZ Artificial Mains Network (For EUT)	ENV216	101195	May 9, 2019	May 8, 2020
LISN With Adapter (for EUT)	101195	N/A	May 9, 2019	May 8, 2020
EMCO L.I.S.N. (For peripherals)	3825/2	9504-2359	Jul. 31, 2019	Jul. 30, 2020
SCHWARZBECK Artificial Mains Network (For EUT)	NNLK8129	8129229	May 14, 2019	May 13, 2020
SCHWARZBECK Artificial Mains Network (For EUT)	NNLK 8121	8121-808	Mar. 15, 2019	Mar. 14, 2020
Software	Cond_V7.3.7.4	NA	NA	NA
RF cable (JYEBAO) With 10dB PAD	5D-FB	Cable-C03-01	Sep. 17, 2019	Sep. 16, 2020
LYNICS Terminator (For EMCO LISN)	0900510	E1-01-300	Jan. 20, 2020	Jan. 19, 2021
LYNICS Terminator (For EMCO LISN)	0900510	E1-01-301	Jan. 20, 2020	Jan. 19, 2021
ROHDE & SCHWARZ Artificial Mains Network (For TV EUT)	ENV216	101196	Apr. 16, 2019	Apr. 15, 2020
LISN With Adapter (for TV EUT)	101196	NA	Apr. 16, 2019	Apr. 15, 2020

Note: 1. The calibration interval of the above test instruments is 12 months and the calibrations are traceable to NML/ROC and NIST/USA.

2. The test was performed in Shielded Room No. 3.

3. The VCCI Site Registration No. C-10274.

4. Tested Date: Feb. 14, 2020

5.3 Test Arrangement

- The EUT was placed 0.4 meters from the conducting wall of the shielded room with EUT being connected to the power mains through a line impedance stabilization network (LISN). Other support units were connected to the power mains through another LISN. The two LISNs provide 50 Ohm/ 50uH of coupling impedance for the measuring instrument.
- Both lines of the power mains connected to the EUT were checked for maximum conducted interference.
- The test results of conducted emissions at mains ports are recorded of six worst margins for quasi-peak (mandatory) [and average (if necessary)] values against the limits at frequencies of interest unless the margin is 20 dB or greater.

Note: The resolution bandwidth and video bandwidth of test receiver is 9kHz for quasi-peak detection (QP) and average detection (AV) at frequency 0.15MHz-30MHz.

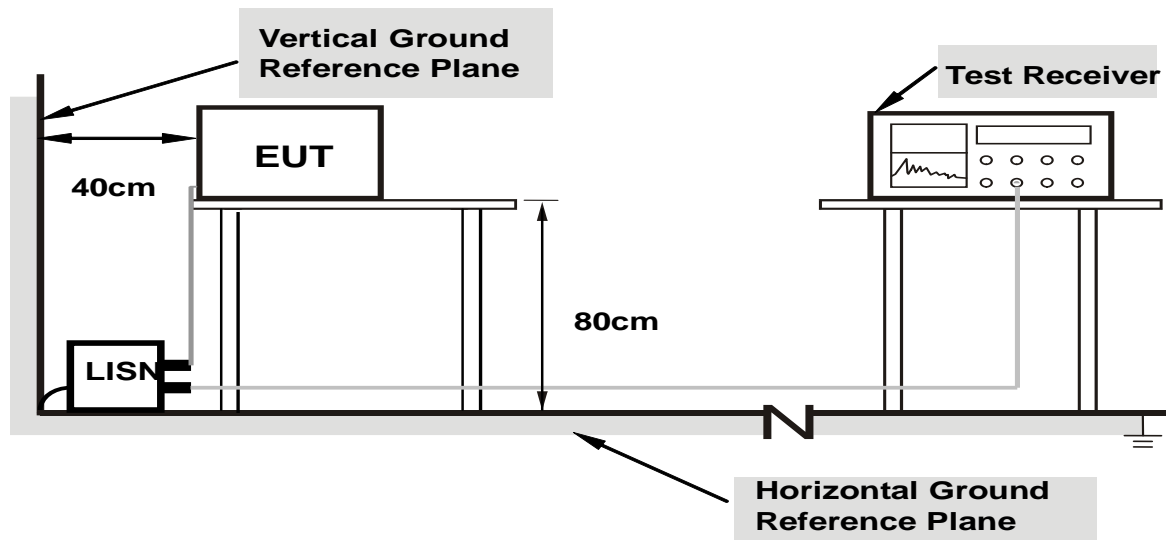

Note: Support units were connected to second LISN.

For the actual test configuration, please refer to the related item – Photographs of the Test Configuration.

5.4 Test Results

Frequency Range	150kHz ~ 30MHz	Detector Function & Resolution Bandwidth	Quasi-Peak (QP) / Average (AV), 9kHz
Input Power	120Vac, 60Hz	Environmental Conditions	25°C, 75%RH
Tested by	Nero Lin		
Test Mode	Mode 1		

Phase Of Power : Line (L)										
No	Frequency (MHz)	Correction Factor (dB)	Reading Value (dBuV)		Emission Level (dBuV)		Limit (dBuV)		Margin (dB)	
			Q.P.	AV.	Q.P.	AV.	Q.P.	AV.	Q.P.	AV.
1	0.15391	9.62	31.96	22.38	41.58	32.00	79.00	66.00	-37.42	-34.00
2	0.23203	9.61	34.80	34.70	44.41	44.31	79.00	66.00	-34.59	-21.69
3	4.94922	9.77	15.18	8.69	24.95	18.46	73.00	60.00	-48.05	-41.54
4	14.15625	9.84	23.75	15.47	33.59	25.31	73.00	60.00	-39.41	-34.69
5	20.39063	9.88	22.51	11.03	32.39	20.91	73.00	60.00	-40.61	-39.09
6	24.20313	9.87	25.29	12.20	35.16	22.07	73.00	60.00	-37.84	-37.93

Remarks:

1. Q.P. and AV. are abbreviations of quasi-peak and average individually.
2. The emission levels of other frequencies were very low against the limit.
3. Margin value = Emission level – Limit value
4. Correction factor = Insertion loss + Cable loss
5. Emission Level = Correction Factor + Reading Value

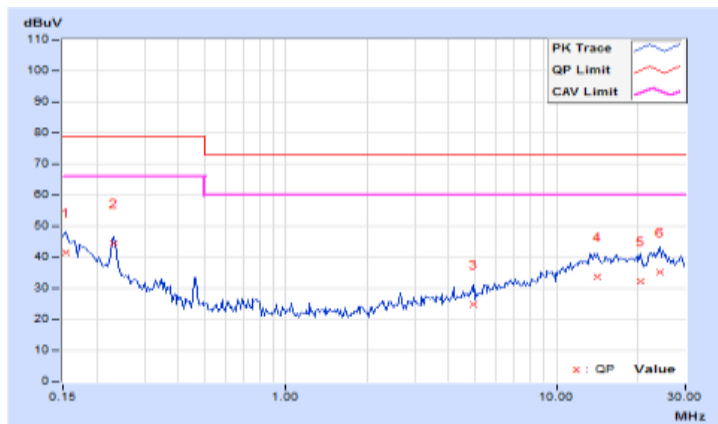

Frequency Range	150kHz ~ 30MHz	Detector Function & Resolution Bandwidth	Quasi-Peak (QP) / Average (AV), 9kHz
Input Power	120Vac, 60Hz	Environmental Conditions	25°C, 75%RH
Tested by	Nero Lin		
Test Mode	Mode 1		

Phase Of Power : Neutral (N)										
No	Frequency (MHz)	Correction Factor (dB)	Reading Value (dBuV)		Emission Level (dBuV)		Limit (dBuV)		Margin (dB)	
			Q.P.	AV.	Q.P.	AV.	Q.P.	AV.	Q.P.	AV.
1	0.15000	9.60	33.67	24.49	43.27	34.09	79.00	66.00	-35.73	-31.91
2	0.23075	9.60	36.43	36.29	46.03	45.89	79.00	66.00	-32.97	-20.11
3	0.46250	9.61	21.41	20.75	31.02	30.36	79.00	66.00	-47.98	-35.64
4	12.14063	9.84	22.06	13.73	31.90	23.57	73.00	60.00	-41.10	-36.43
5	22.95703	9.93	20.93	10.08	30.86	20.01	73.00	60.00	-42.14	-39.99
6	29.74219	9.98	23.02	14.79	33.00	24.77	73.00	60.00	-40.00	-35.23

Remarks:

1. Q.P. and AV. are abbreviations of quasi-peak and average individually.
2. The emission levels of other frequencies were very low against the limit.
3. Margin value = Emission level – Limit value
4. Correction factor = Insertion loss + Cable loss
5. Emission Level = Correction Factor + Reading Value

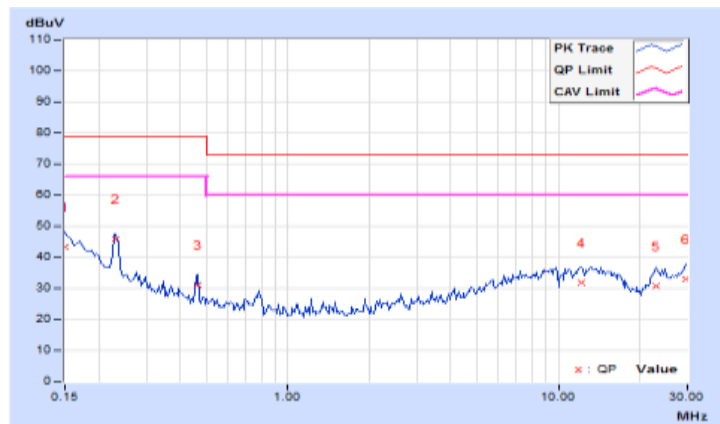

6 Radiated Emissions up to 1 GHz

6.1 Limits

Emissions radiated outside of the specified bands, shall be according to the general radiated limits as following:

Radiated Emissions Limits at 10 meters (dB μ V/m)				
Frequencies (MHz)	FCC 15B / ICES-003, Class A	FCC 15B / ICES-003, Class B	CISPR 22, Class A	CISPR 22, Class B
30-88	39	29.5	40	30
88-216	43.5	33.1		
216-230	46.4	35.6		
230-960				
960-1000	49.5	43.5	47	37

Radiated Emissions Limits at 3 meters (dB μ V/m)				
Frequencies (MHz)	FCC 15B / ICES-003, Class A	FCC 15B / ICES-003, Class B	CISPR 22, Class A	CISPR 22, Class B
30-88	49.5	40	50.5	40.5
88-216	54	43.5		
216-230	56.9	46		
230-960				
960-1000	60	54	57.5	47.5

- Notes:
1. The lower limit shall apply at the transition frequencies.
 2. Emission level (dB μ V/m) = 20 log Emission level (uV/m).
 3. QP detector shall be applied if not specified.

6.2 Test Instruments

Description & Manufacturer	Model No.	Serial No.	Cal. Date	Cal. Due
ROHDE & SCHWARZ TEST RECEIVER	ESCS 30	100027	May 13, 2019	May 12, 2020
Schwarzbeck Bilog Antenna	VULB9168	9168-303	Nov. 11, 2019	Nov. 10, 2020
Agilent Preamplifier	8447D	2944A08119	Feb. 20, 2019	Feb. 19, 2020
ADT. Turn Table	TT100	0205	NA	NA
ADT. Tower	AT100	0205	NA	NA
Software	Radiated_V7.6.15.9.5	NA	NA	NA
ADT RF Switches BOX	EMH-011	1001	Oct. 24, 2019	Oct. 23, 2020
Pacific RF cable With 5dB PAD	8D	CABLE-ST2-01	Oct. 24, 2019	Oct. 23, 2020

- Note:
1. The calibration interval of the above test instruments is 12 months and the calibrations are traceable to NML/ROC and NIST/USA.
 2. The test was performed in Open Site No. 2.
 3. The VCCI Site Registration No. R-10237.
 4. Tested Date: Feb. 12, 2020

6.3 Test Arrangement

- The EUT was placed on the top of a rotating table 0.8 meters above the ground at an accredited test facility. The table was rotated 360 degrees to determine the position of the highest radiation.
- The EUT was set 10 meters away from the interference-receiving antenna, which was mounted on the top of a variable-height antenna tower.
- The antenna is a broadband antenna, and its height is varied from one meter to four meters above the ground to determine the maximum value of the field strength. Both horizontal and vertical polarizations of the antenna are set to make the measurement.
- For each suspected emission, the EUT was arranged to its worst case and then the antenna was tuned to heights from 1 meter to 4 meters and the rotatable table was turned from 0 degrees to 360 degrees to find the maximum reading.
- The test-receiver system was set to quasi-peak detect function and specified bandwidth with maximum hold mode when the test frequency is up to 1 GHz.

Note: The resolution bandwidth and video bandwidth of test receiver/spectrum analyzer is 120kHz for quasi-peak detection (QP) at frequency up to 1GHz.

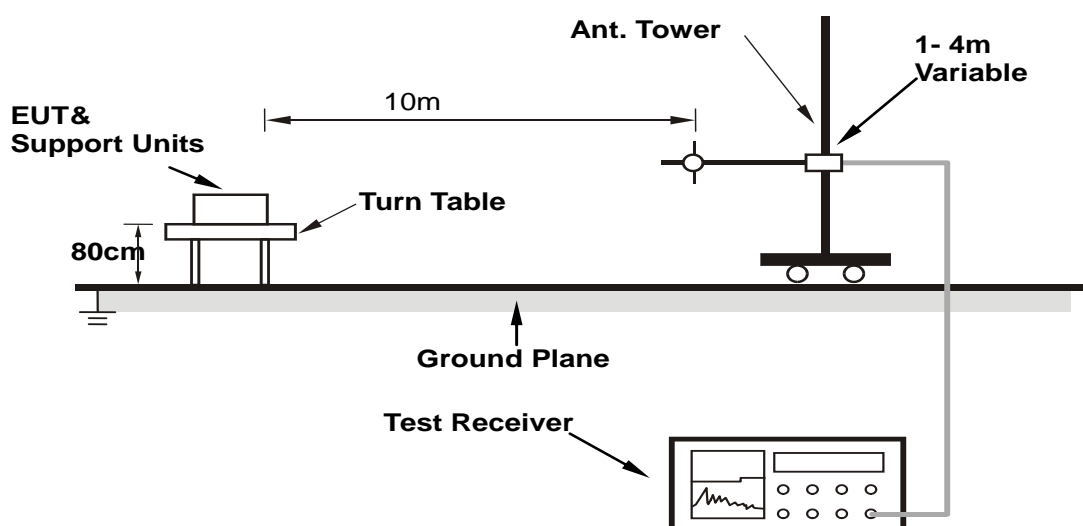

For the actual test configuration, please refer to the related item – Photographs of the Test Configuration.

6.4 Test Results

Frequency Range	30MHz ~ 1GHz	Detector Function & Resolution Bandwidth	Quasi-Peak (QP), 120kHz
Input Power	120Vac, 60Hz	Environmental Conditions	23°C, 67%RH
Tested by	ED. Lin		
Test Mode	Mode 1		

Antenna Polarity & Test Distance : Horizontal at 10 m

No	Frequency (MHz)	Emission Level (dBuV/m)	Limit (dBuV/m)	Margin (dB)	Antenna Height (m)	Table Angle (Degree)	Raw Value (dBuV)	Correction Factor (dB/m)
1	137.89	35.75 QP	40.00	-4.25	3.83 H	1	45.96	-10.21
2	181.50	32.61 QP	40.00	-7.39	3.13 H	1	43.74	-11.13
3	259.32	43.00 QP	47.00	-4.00	3.13 H	21	52.51	-9.51
4	445.75	41.67 QP	47.00	-5.33	2.43 H	163	46.15	-4.48
5	593.99	45.67 QP	47.00	-1.33	1.68 H	18	46.93	-1.26
6	742.50	46.30 QP	47.00	-0.70	1.32 H	182	44.56	1.74
7	891.00	46.00 QP	47.00	-1.00	1.04 H	171	41.29	4.71
8	973.75	45.50 QP	47.00	-1.50	1.00 H	272	39.31	6.19

Remarks:

1. Emission Level(dBuV/m) = Raw Value(dBuV) + Correction Factor(dB/m)
2. Correction Factor(dB/m) = Antenna Factor (dB/m) + Cable Factor (dB)
– Pre-Amplifier Factor (dB)
3. The other emission levels were very low against the limit.
4. Margin value = Emission level – Limit value

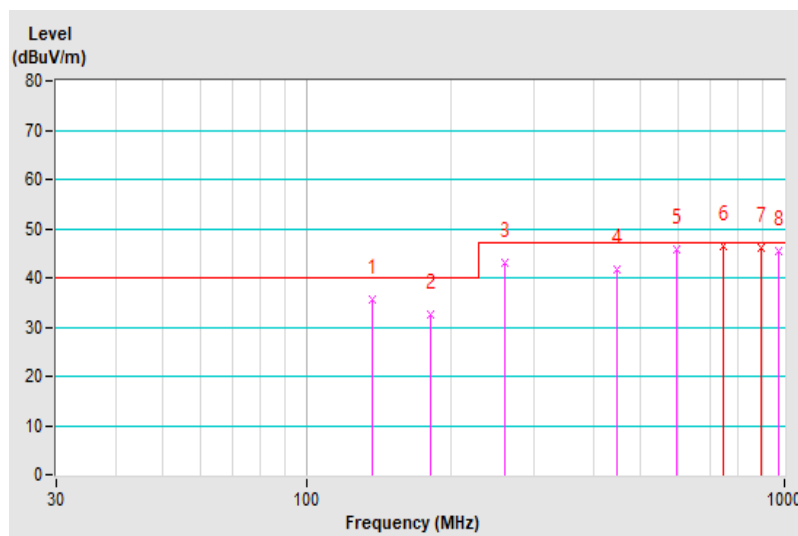

Frequency Range	30MHz ~ 1GHz	Detector Function & Resolution Bandwidth	Quasi-Peak (QP), 120kHz
Input Power	120Vac, 60Hz	Environmental Conditions	23°C, 67%RH
Tested by	ED. Lin		
Test Mode	Mode 1		

Antenna Polarity & Test Distance : Vertical at 10 m								
No	Frequency (MHz)	Emission Level (dBuV/m)	Limit (dBuV/m)	Margin (dB)	Antenna Height (m)	Table Angle (Degree)	Raw Value (dBuV)	Correction Factor (dB/m)
1	73.94	35.22 QP	40.00	-4.78	1.36 V	222	48.65	-13.43
2	95.30	31.79 QP	40.00	-8.21	1.00 V	21	46.99	-15.20
3	135.75	38.26 QP	40.00	-1.74	1.00 V	1	48.61	-10.35
4	147.65	37.38 QP	40.00	-2.62	1.00 V	287	47.04	-9.66
5	195.23	33.63 QP	40.00	-6.37	1.00 V	298	46.06	-12.43
6	297.15	39.86 QP	47.00	-7.14	1.00 V	21	47.81	-7.95
7	445.75	42.71 QP	47.00	-4.29	1.00 V	1	47.19	-4.48
8	594.25	37.95 QP	47.00	-9.05	3.87 V	245	39.19	-1.24
9	742.75	40.38 QP	47.00	-6.62	2.71 V	16	38.63	1.75
10	973.75	42.62 QP	47.00	-4.38	1.88 V	1	36.43	6.19

Remarks:

1. Emission Level(dBuV/m) = Raw Value(dBuV) + Correction Factor(dB/m)
2. Correction Factor(dB/m) = Antenna Factor (dB/m) + Cable Factor (dB) – Pre-Amplifier Factor (dB)
3. The other emission levels were very low against the limit.
4. Margin value = Emission level – Limit value

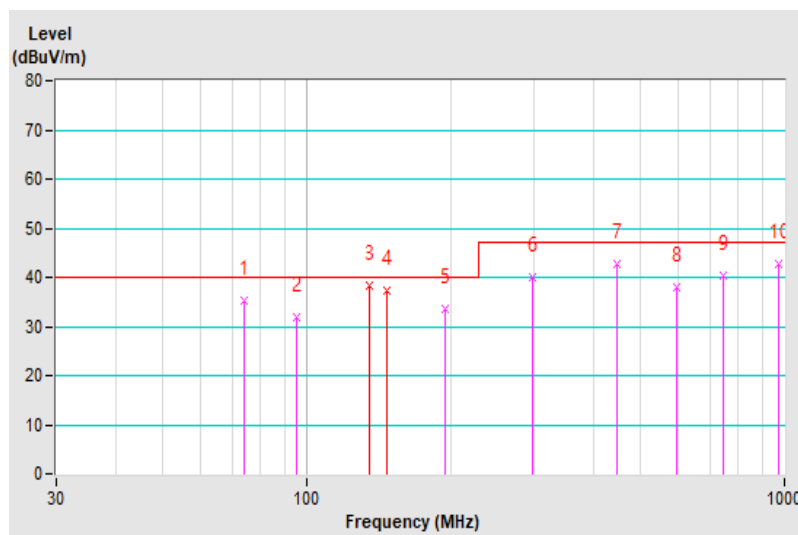

7 Radiated Emissions above 1 GHz

7.1 Limits

Emissions radiated outside of the specified bands, shall be according to the general radiated limits as following:

Radiated Emissions Limits at 10 meters (dB μ V/m)				
Frequencies (MHz)	FCC 15B / ICES-003, Class A	FCC 15B / ICES-003, Class B	CISPR 22, Class A	CISPR 22, Class B
1000-3000	Avg: 49.5	Avg: 43.5	Not defined	Not defined
Above 3000	Peak: 69.5	Peak: 63.5	Not defined	Not defined

Radiated Emissions Limits at 3 meters (dB μ V/m)				
Frequencies (MHz)	FCC 15B / ICES-003, Class A	FCC 15B / ICES-003, Class B	CISPR 22, Class A	CISPR 22, Class B
1000-3000	Avg: 60	Avg: 54	Avg: 56 Peak: 76	Avg: 50 Peak: 70
Above 3000	Peak: 80	Peak: 74	Avg: 60 Peak: 80	Avg: 54 Peak: 74

- Notes:
1. The lower limit shall apply at the transition frequencies.
 2. Emission level (dB μ V/m) = 20 log Emission level (uV/m).
 3. As shown in 15.35(b), for frequencies above 1000MHz, the field strength limits are based on average detector, however, the peak field strength of any emission shall not exceed the maximum permitted average limits, specified above by more than 20dB under any condition of modulation.

Frequency Range (For unintentional radiators)

Highest frequency generated or used in the device or on which the device operates or tunes (MHz)	Upper frequency of measurement range (MHz)
Below 1.705	30
1.705-108	1000
108-500	2000
500-1000	5000
Above 1000	5th harmonic of the highest frequency or 40GHz, whichever is lower

7.2 Test Instruments

Description & Manufacturer	Model No.	Serial No.	Cal. Date	Cal. Due
Agilent Spectrum	E4446A	MY51100009	Jun. 6, 2019	Jun. 5, 2020
Agilent Test Receiver	N9038A	MY51210137	Jun. 6, 2019	Jun. 5, 2020
EMCI Preamplifier	EMC0126545	980076	Feb. 21, 2019	Feb. 20, 2020
MITEQ Preamplifier	AMF-6F-260400-33-8P	892164	Feb. 21, 2019	Feb. 20, 2020
EMCI Preamplifier	EMC184045B	980235	Feb. 21, 2019	Feb. 20, 2020
ETS Preamplifier	3117-PA	00215857	Nov. 24, 2019	Nov. 23, 2020
Schwarzbeck Horn Antenna	BBHA-9170	212	Nov. 24, 2019	Nov. 23, 2020
EMCO Horn Antenna	3115	9312-4192	Nov. 24, 2019	Nov. 23, 2020
Max Full. Turn Table & Tower	MF7802	MF780208103	NA	NA
Software	Radiated_V8.7.08	NA	NA	NA
SUHNER RF cable With 3/4dB PAD	SF102	Cable-CH7-3.6m	Jul. 10, 2019	Jul. 9, 2020
MICRO-TRONICS Notch filter	BRC50703-01	010	May 30, 2019	May 29, 2020
MICRO-TRONICS Band Pass Filter	BRM17690	005	May 30, 2019	May 29, 2020

- Note:
1. The calibration interval of the above test instruments is 12 months and the calibrations are traceable to NML/ROC and NIST/USA.
 2. The test was performed in Chamber No. 7.
 3. The VCCI Site Registration No. G-10039
 4. Tested Date: Feb. 15, 2020

7.3 Test Arrangement

- The EUT was placed on the top of a rotating table 0.8 meters above the ground at an accredited chamber room. The table was rotated 360 degrees to determine the position of the highest radiation.
- The EUT was set 3 meters away from the interference-receiving antenna, which was mounted on the top of a variable-height antenna tower.
- The height of antenna can be varied from one meter to four meters, the height of adjustment depends on the EUT height and the antenna 3dB beamwidth both, to detect the maximum value of the field strength. Both horizontal and vertical polarizations of the antenna are set to make the measurement.
- For each suspected emission, the EUT was arranged to its worst case and then the antenna was tuned to heights and the rotatable table was turned from 0 degrees to 360 degrees to find the maximum reading.
- The spectrum analyzer system was set to peak and average detect function and specified bandwidth with maximum hold mode when the test frequency is above 1 GHz.

Note: The resolution bandwidth of test receiver/spectrum analyzer is 1MHz and video bandwidth is 3MHz for Peak detection (PK) at frequency above 1GHz. The resolution bandwidth of test receiver/spectrum analyzer is 1 MHz for Average detection (AV) at frequency above 1GHz.

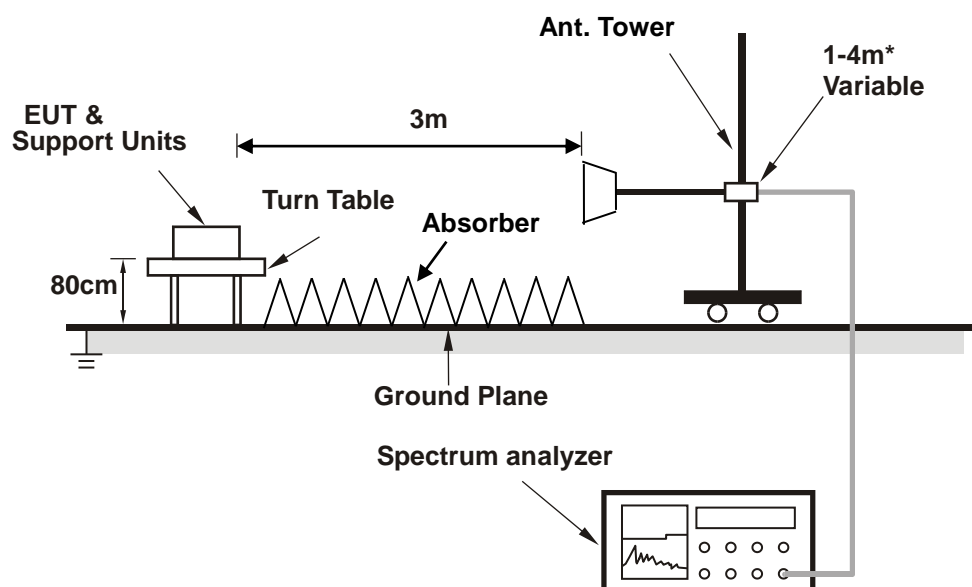

* :depends on the EUT height and the antenna 3dB beamwidth both.

For the actual test configuration, please refer to the related item – Photographs of the Test Configuration.

7.4 Test Results

Frequency Range	1GHz ~ 22GHz	Detector Function & Resolution Bandwidth	Peak (PK) / Average (AV), 1MHz
Input Power	120Vac, 60Hz	Environmental Conditions	23°C, 79%RH
Tested by	Adam Chen		
Test Mode	Mode 1		

Antenna Polarity & Test Distance : Horizontal at 3 m

No	Frequency (MHz)	Emission Level (dBuV/m)	Limit (dBuV/m)	Margin (dB)	Antenna Height (m)	Table Angle (Degree)	Raw Value (dBuV)	Correction Factor (dB/m)
1	1039.52	53.16 PK	80.00	-26.84	1.43 H	129	56.29	-3.13
2	1039.52	49.69 AV	60.00	-10.31	1.43 H	129	52.82	-3.13
3	1187.93	54.83 PK	80.00	-25.17	2.79 H	158	57.15	-2.32
4	1187.93	46.45 AV	60.00	-13.55	2.79 H	158	48.77	-2.32
5	2079.01	58.64 PK	80.00	-21.36	1.19 H	20	58.14	0.50
6	2079.01	46.03 AV	60.00	-13.97	1.19 H	20	45.53	0.50
7	2227.44	62.32 PK	80.00	-17.68	2.60 H	357	62.21	0.11
8	2227.44	51.08 AV	60.00	-8.92	2.60 H	357	50.97	0.11

Remarks:

1. Emission Level(dBuV/m) = Raw Value(dBuV) + Correction Factor(dB/m)
2. Correction Factor(dB/m) = Antenna Factor (dB/m) + Cable Factor (dB) – Pre-Amplifier Factor (dB)
3. The other emission levels were very low against the limit.
4. Margin value = Emission level – Limit value

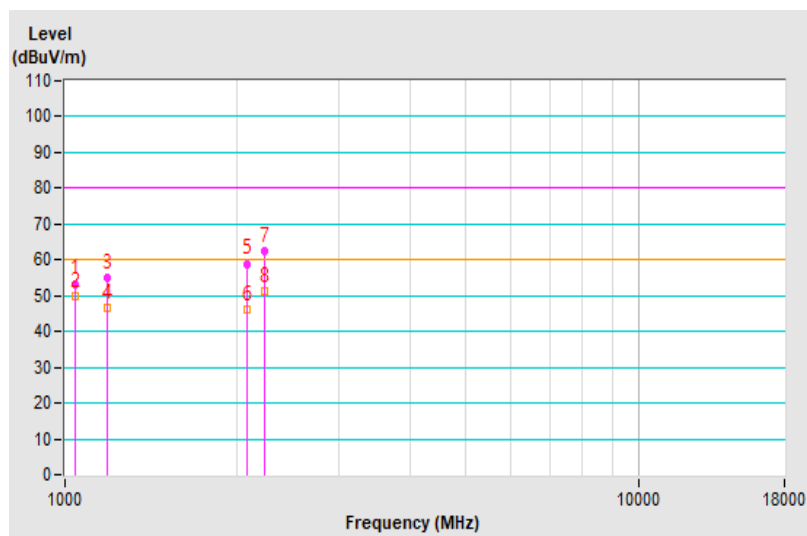

Frequency Range	1GHz ~ 22GHz	Detector Function & Resolution Bandwidth	Peak (PK) / Average (AV), 1MHz
Input Power	120Vac, 60Hz	Environmental Conditions	23°C, 79%RH
Tested by	Adam Chen		
Test Mode	Mode 1		

Antenna Polarity & Test Distance : Vertical at 3 m								
No	Frequency (MHz)	Emission Level (dBuV/m)	Limit (dBuV/m)	Margin (dB)	Antenna Height (m)	Table Angle (Degree)	Raw Value (dBuV)	Correction Factor (dB/m)
1	2079.01	61.46 PK	80.00	-18.54	1.00 V	153	60.96	0.50
2	2079.01	48.21 AV	60.00	-11.79	1.00 V	153	47.71	0.50
3	2227.43	63.82 PK	80.00	-16.18	2.61 V	201	63.71	0.11
4	2227.43	52.04 AV	60.00	-7.96	2.61 V	201	51.93	0.11
5	2375.97	58.32 PK	80.00	-21.68	1.15 V	139	57.65	0.67
6	2375.97	45.41 AV	60.00	-14.59	1.15 V	139	44.74	0.67
7	3712.48	61.23 PK	80.00	-18.77	1.00 V	172	56.01	5.22
8	3712.48	53.67 AV	60.00	-6.33	1.00 V	172	48.45	5.22

Remarks:

1. Emission Level(dBuV/m) = Raw Value(dBuV) + Correction Factor(dB/m)
2. Correction Factor(dB/m) = Antenna Factor (dB/m) + Cable Factor (dB) – Pre-Amplifier Factor (dB)
3. The other emission levels were very low against the limit.
4. Margin value = Emission level – Limit value

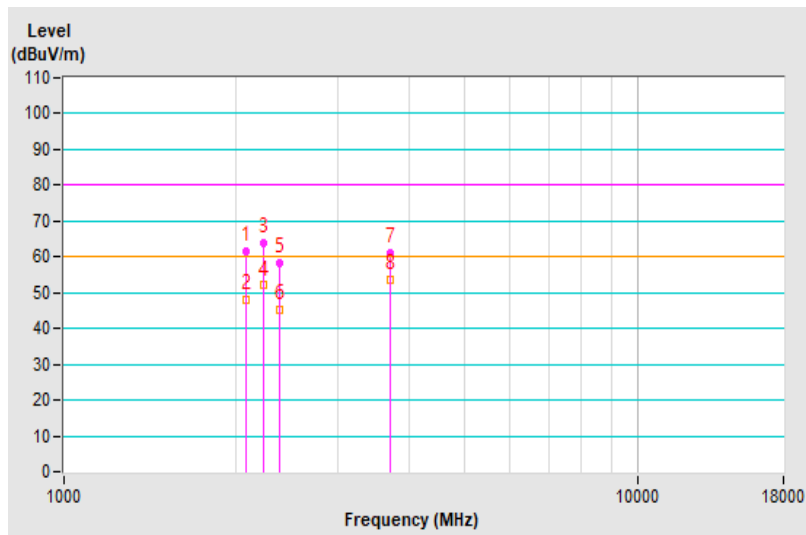

8 Pictures of Test Arrangements

8.1 Conducted Emissions at Mains Ports



8.2 Radiated Emissions up to 1 GHz



8.3 Radiated Emissions above 1 GHz



Appendix – Information of the Testing Laboratories

We, Bureau Veritas Consumer Products Services (H.K.) Ltd., Taoyuan Branch, were founded in 1988 to provide our best service in EMC, Radio, Telecom and Safety consultation. Our laboratories are FCC recognized accredited test firms and accredited according to ISO/IEC 17025.

If you have any comments, please feel free to contact us at the following:

Lin Kou EMC/RF Lab

Tel: 886-2-26052180

Fax: 886-2-26051924

Hsin Chu EMC/RF/Telecom Lab

Tel: 886-3-6668565

Fax: 886-3-6668323

Hwa Ya EMC/RF/Safety Lab

Tel: 886-3-3183232

Fax: 886-3-3270892

Email: service.adt@tw.bureauveritas.com

Web Site: www.bureauveritas-adt.com

The address and road map of all our labs can be found in our web site also.

--- END ---